LCD CONNECTOR From <http://www.lcd-cable.com/>

MODEL:	Other connector
SIZE:	Other connector
PACKAGE:	Other connector

Custom **LCD CONNECTOR**

Design and manufacture of custom **eDP cable,IPEX LVDS cable,LVDS cable,LCD cable, LCD Ribbon cable**

in small gauge co-axial cable, professional in SGC/MCC/MCX/Micro Coax

assembly for LED backlight **LCD** & flat-panel displays and their peripheral,

widely used in **medical equipment**,high-end automated test equipment,and

security applications.

Key Specifications/Special Features:

1) Cable Materials:UL10064 #32AWG-#36AWG **UL1354** #36AWG-#42AWG SUMITOMO/HITACHI

2) Common used connector brand:

I-PEX/STARCONN/Hirose/UJU/ACES/HONDA/TYCO/JAE/KEL/STM etc

3) Pitch: 0.3mm/0.4mm/0.5mm/0.8mm/1.0mm/1.25mm Pitch

4) Application:

All kinds of LVDS cable,**LCD cable**,eDP cable,IPEX cable,SGC cable,Diagnostic Cable, **LVDS Ribbon cable**,MCX cable,

MCC cable,Micro Coaxial cable, **IPEX LVDS cable**,Round cable,HDMI cable,D-Sub cable,SCSI cable,Display port cable,FFC cable,USB cable for

LCD panel,widely used in LAPTOP/IPAD/HDTV/DPD/GPS/LCD TV/LED TV/

LCD MONITOR/LED MONITOR/NOTEBOOK/DISPLAY/PROJECTOR etc.

5) OEM and ODM orders are welcome. Please contact us for what you need:

E-mail: JACKY@LCD-CABLE.COM Skype: [JACKY882010](https://www.skype.com/people/JACKY882010)

Common used connector part number:

I-PEX20453-020T,I-PEX20455-020E,I-PEX20453-030T,**I-PEX20455-030E**,

I-PEX20455-040E,I-PEX20453-040T,**I-PEX20455-050E**,I-PEX20453-050T,

I-PEX20524-030T,**I-PEX20525-030E**,I-PEX20524-040T,I-PEX20525-040E

I-PEX20472-030T,**I-PEX20474-030E**,I-PEX20472-040T,**I-PEX20474-040E**

I-PEX20346-030T,I-PEX20347-030E,I-PEX20345-040T,I-PEX20347-040E

I-PEX20373-020T,I-PEX20374-020E,**I-PEX20373-030T**,I-PEX20374-030E

I-PEX20373-040T,I-PEX20374-040E,I-PEX20373-050T,I-PEX20374-050E

I-PEX20438-040T,I-PEX20439-040E,I-PEX20438-050T,**I-PEX20439-050E**,

I-PEX20320-040T,I-PEX20320-050T,I-PEX20338-044T,I-PEX20384-040T

JAE FI-RE41CL,**JAE FI-RE51CL**,JAE FI-X30CL,JAE FI-X30C,JAE FI-NX40CL

JAE FI-J30C,JAE FI-JH30C,JAE FI-JT30C,**JAE FI-VHP50C**,JAE FI-D44C

JAE HD1S040HA1,TYCO 2023344-2,2023344-3,TYCO **5-2069716-3**,

TYCO 5-2069716-2,Starconn 111A40-000RA-G3,Foxconn HF5508

HIROSE DF19-20S,KEL SL,KEL SSL,KEL USL,KEL XSL,KEL USLS

HONDA LVC-C20LPMSG+,HONDA **LVC-D20LPMSG+**,HONDA LVC-D20SFYG

HONDA LVC-C30LPMSG+,HONDA LVC-D30LPMSG+,**HONDA LVC-D30SFYG**

HONDA LVC-C40LPMSG+,HONDA LVC-D40LPMSG+,HONDA LVC-D40SFYG

HONDA **LVX-A30LMSG+**,HONDA **LVX-A30SFYG+**

HONDA LVX-A40LMSG+,HONDA LVX-A40SFYG+

ACES88441-040/ACES50203-040/ACES88341-040

ACES 91209-01011/ACES 91214/ACES 88107



eDP cable

NEW



E-MAIL: JACKY@LCD-CABLE.COM



E-MAIL: JACKY@LCD-CABLE.COM

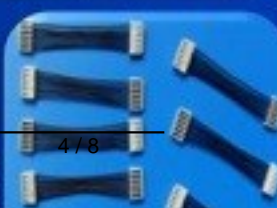

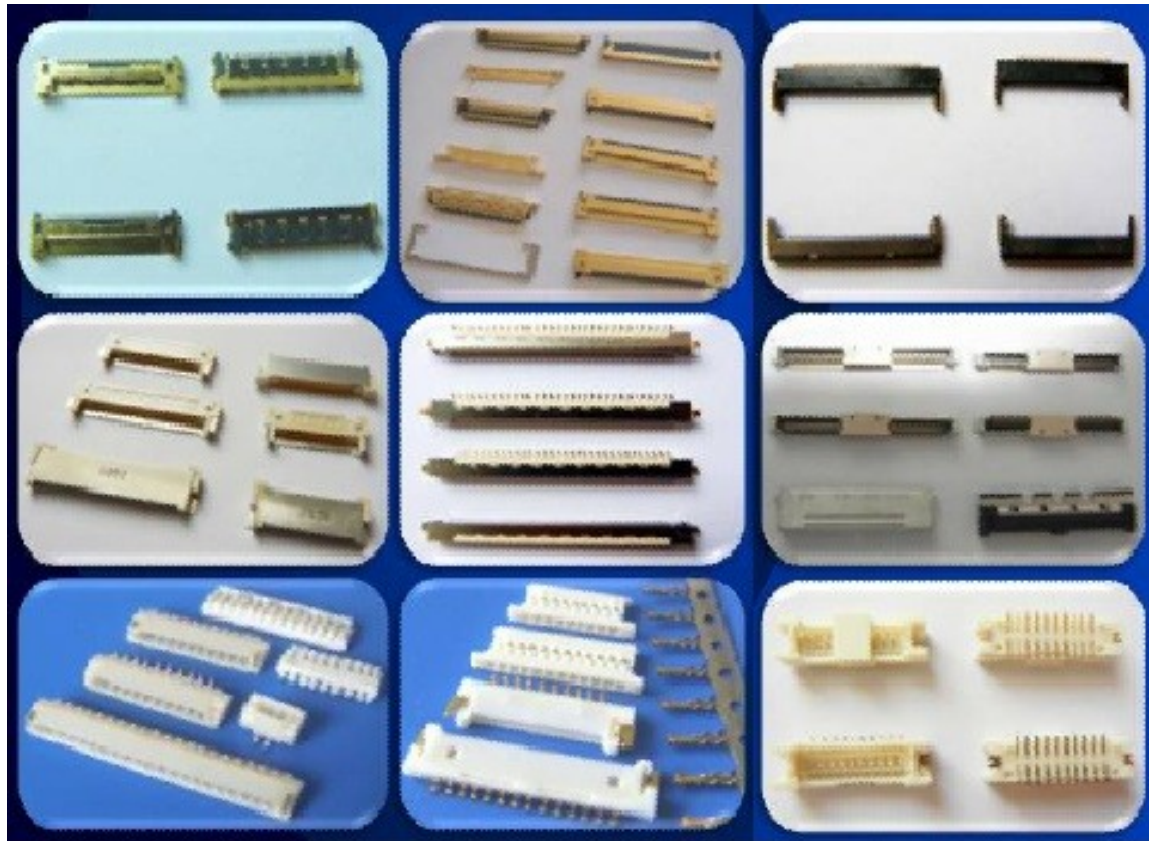

Skype: [jacky882010](https://www.skype.com/user/jacky882010) MSN: jacky882010@hotmail.com

[HTTP://WWW.LCD-CABLE.COM](http://www.lcd-cable.com)



RoHS
Compliant



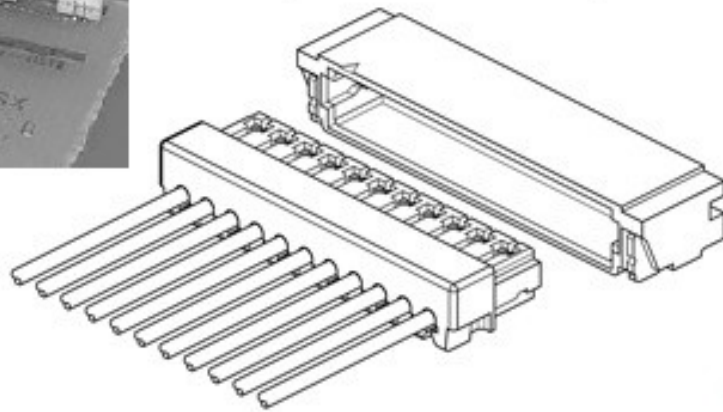
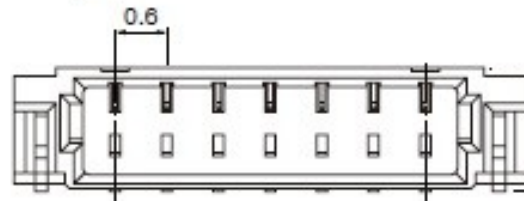
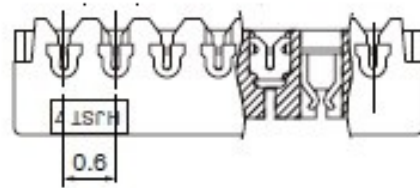
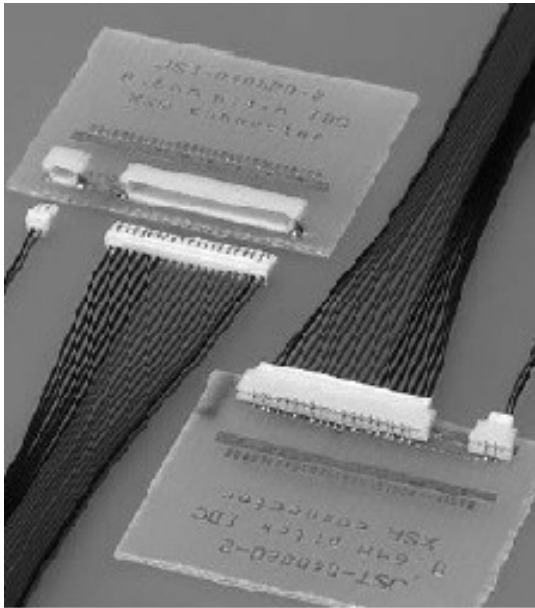

Skype: [jacky882010](https://www.skype.com/user/jacky882010) MSN: jacky882010@hotmail.com

[HTTP://WWW.LCD-CABLE.COM](http://www.lcd-cable.com)



RoHS
Compliant





JST

Skype:

HTTP



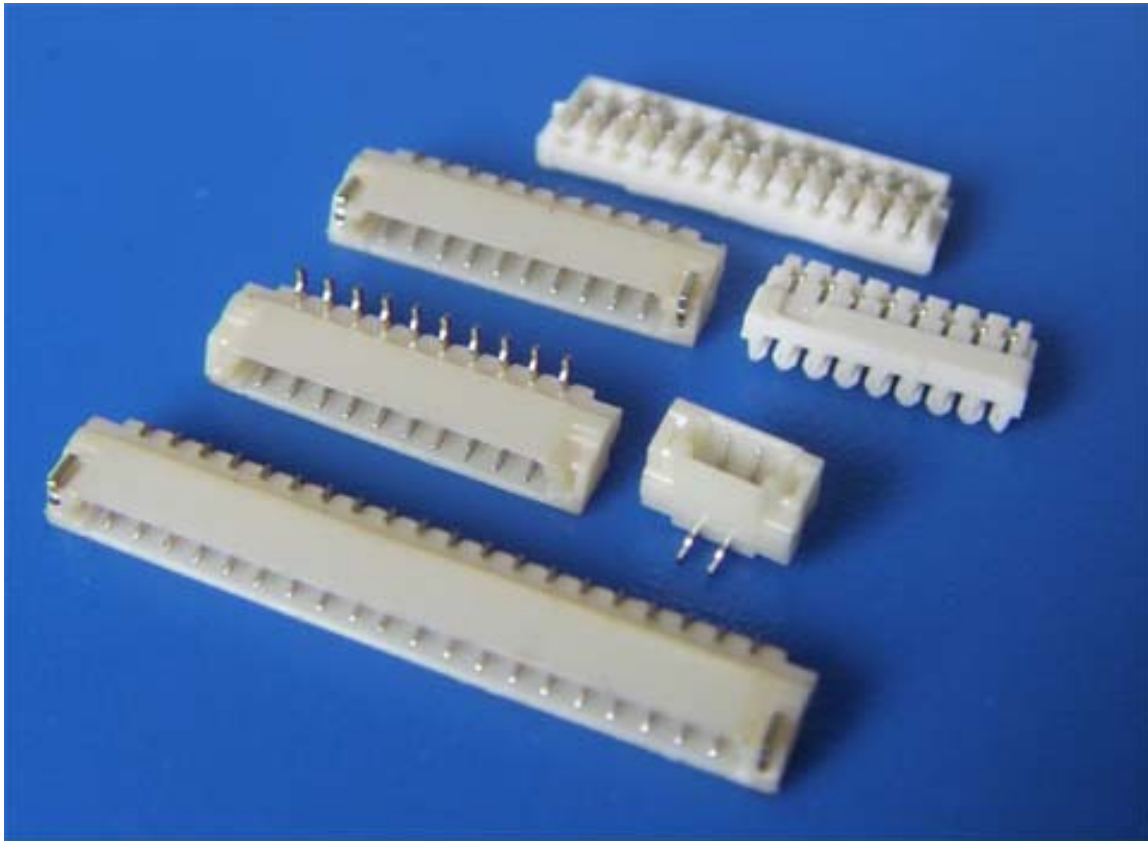

Skype: [jacky882010](https://www.skype.com/user/jacky882010) MSN: jacky882010@hotmail.com

[HTTP://WWW.LCD-CABLE.COM](http://www.lcd-cable.com)



RoHS
Compliant



SGS



click!